

Product Detail

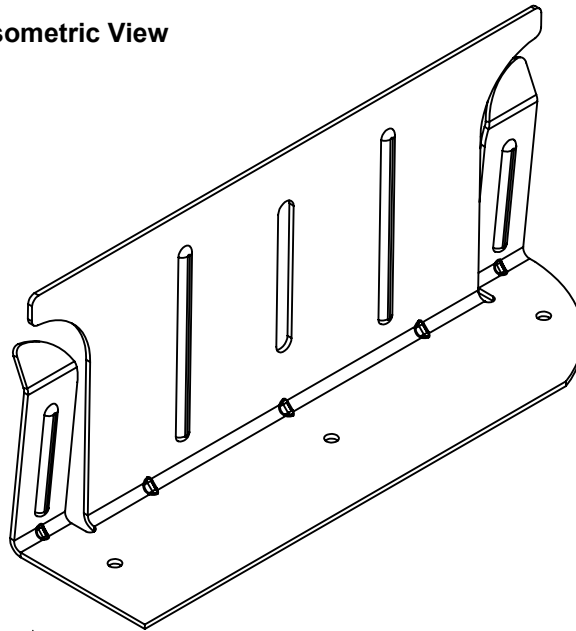

Three Legged Dog 8" Deflection Clip

Isometric View



Specifications

Channel:

- ASTM A653, structural grade 50, hot dipped galvanized steel
- Standard protective coating equal or superior to ASTM A653 coating designation G-60
- 16 gauge

Alternate Views

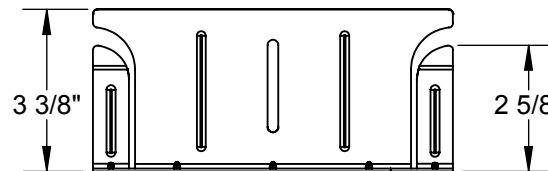
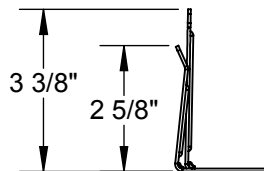
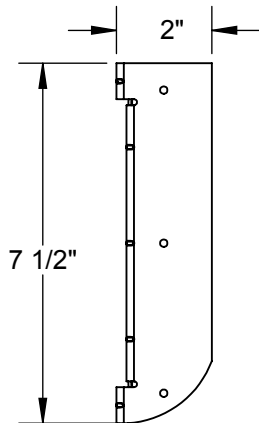

**FLEX-ABILITY
CONCEPTS**

Distributor:
Contractor:
For Product Line PDM
Product Detail: PDM46

Quantity:
Approved By:
Architect:
Date:

3840 N. Tulsa Ave
Oklahoma City, OK, 73112
Tel: 405-996-5343 Fax: 405-996-5353
E-mail: info@flexabilityconcepts.com
Web: www.flexabilityconcepts.com